

DOWNLIGHT MONTANA 2 825 27W 90°x50° GREY BREAD ON/OFF

Article number: N217-K0001-VF825-H8-###-ZC02_700-##-###

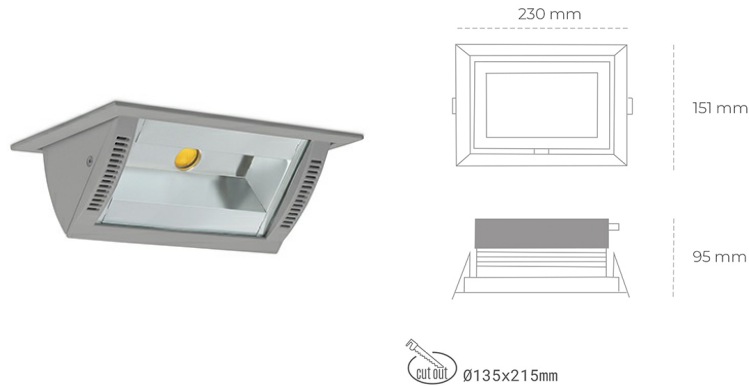

LED	COB
Light colour	2500 [K] BREAD
CRI	80
Led chip flux	3169 [lm]
Luminous flux	2535 [lm]
System power	27 [W]
Luminaire Efficiency	94 [lm/W]
Beam angle	36°
Controller	ON/OFF
MacAdam	3 SDCM

Downlight LED

Wall-washer LED downlight for drop ceiling installation. Aluminium housing. Glass cover included. Available in white, black and grey. Any RAL palette colour available on enquiry. Maximum power is 37W.

LUMINAIRE

Weight	1,258 [kg]
Protection rating IP , IK , class	IP 20, IK 3,
Luminaire colour	GREY
Cover	Glass
Operating voltage	220-240V 50-60Hz

Note: All data are typical values. Tolerance of measurements +/-10% System features may change with product improvements due to technical advances.

OPTIONS

RAL colours on inquiry, Casambi on inquiry, DALI on inquiry, Phase-cut dimming on inquiry.



Generated: 26.06.2024



+48 32 388 80 00



www.cora.pl
cora@cora.pl



Street: Ignatza Hakuby 18
41-914 Bytom, Polska