

DOWNLIGHT CYGNUS Z1 930 25W 60° BLACK HI EFFICIENT ON/OFF

Article number: N214-K0002-BB930-H8-H60-ZC02_650-S6-###

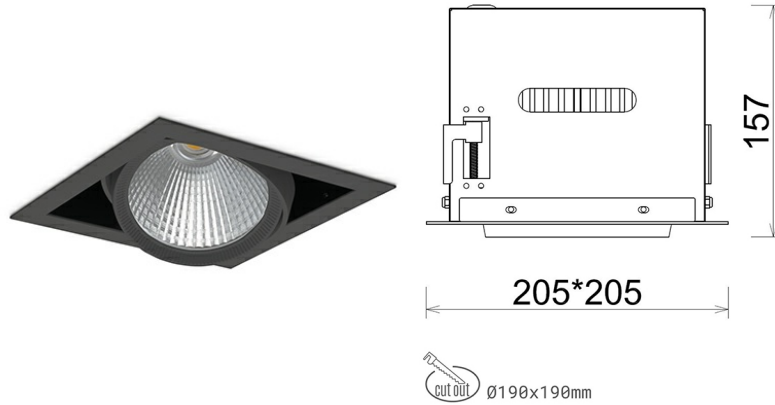

LED	COB
Light colour	3000 [K] HI EFFICIENT
CRI	90
Led chip flux	4084 [lm]
Luminous flux	3267 [lm]
System power	25 [W]
Luminaire Efficiency	131 [lm/W]
Beam angle	60°
Controller	ON/OFF
MacAdam	3 SDCM

Downlight LED

LED downlight for drop ceiling installation. Aluminium housing. Available in white and black. Any RAL palette colour available on enquiry. Housing enables adjustment in two axis planes. Glass cover included. Reflector beams available: 15°, 30°, 45° and 60°. Maximum power is 37W

LUMINAIRE

Weight	2,05 [kg]
Protection rating IP , IK , class	IP 20, IK 3,
Luminaire colour	BLACK
Cover	Glass
Operating voltage	220-240V 50-60Hz

Note: All data are typical values. Tolerance of measurements +/-10% System features may change with product improvements due to technical advances.

OPTIONS

RAL colours on inquiry, honeycomb louver on inquiry , Casambi on inquiry, DALI on inquiry, Phase-cut dimming on inquiry.



Generated: 16.07.2024



+48 32 388 80 00



www.cora.pl
cora@cora.pl



Street: Ignatza Hakuby 18
41-914 Bytom, Polska