

DOWNLIGHT SHERIFF Z BATWING 930 19W 90°x50° WHITE HI EFFICIENT ON/OFF

Article number: N207-K0003-BB930-H8-ZBW-ZC01_500-B1-###

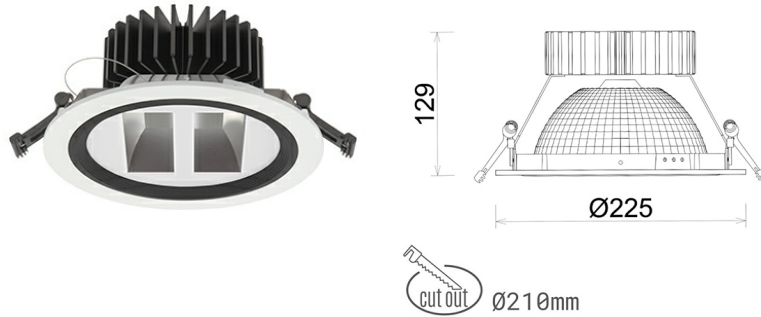

LED	COB
Light colour	3000 [K] HI EFFICIENT
CRI	90
Led chip flux	3184 [lm]
Luminous flux	2547 [lm]
System power	19 [W]
Luminaire Efficiency	134 [lm/W]
Beam angle	90°x50°
Controller	ON/OFF
MacAdam	3 SDCM

Downlight LED

LED downlight for drop ceiling installation. Aluminium housing. Glass cover included. Available in white, black and grey. Any RAL palette colour available on enquiry. Special double asymmetric optics. Maximum power is 37W.

LUMINAIRE

Weight	1,23 [kg]
Protection rating IP , IK , class	IP 20, IK 3,
Luminaire colour	WHITE
Cover	Plastic
Operating voltage	220-240V 50-60Hz

Note: All data are typical values. Tolerance of measurements +/-10% System features may change with product improvements due to technical advances.

OPTIONS

RAL colours on enquiry, Casambi on enquiry, DALI on enquiry, Phase-cut dimming on enquiry.



Generated: 26.06.2024



+48 32 388 80 00



www.cora.pl
cora@cora.pl



Street: Ignatza Hakuby 18
41-914 Bytom, Polska