

SPOTLIGHT SNIPER G MAXI 840 25W 45° BLACK | ON/OFF

Article number: N014-K0002-RF840-H5-S45-ZA02_650-S3-###

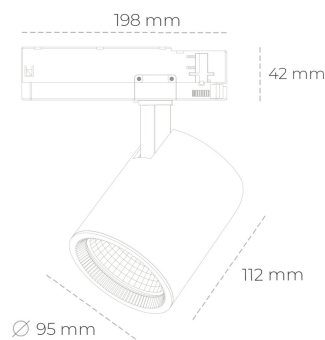

LED	COB
Light colour	4000 [K]
CRI	80
Led chip flux	3690 [lm]
Luminous flux	2952 [lm]
System power	25 [W]
Luminaire Efficiency	118 [lm/W]
Beam angle	45°
Controller	ON/OFF
MacAdam	3 SDCM

Spotlight LED

Track mounted LED spotlight. Aluminium housing. Ceiling base installation possible. Available in white, black and grey. Any RAL palette colour available on enquiry. Reflector beams available: 15°, 20°, 30°, 45° and 60°. Maximum power is 30W

LUMINAIRE

Weight	1,02 [kg]
Protection rating IP , IK , class	IP 20, IK 1,
Luminaire colour	BLACK
Cover	Glass
Operating voltage	220-240V 50-60Hz

Note: All data are typical values. Tolerance of measurements +/-10% System features may change with product improvements due to technical advances.

OPTIONS

RAL colours on inquiry, honeycomb louver on inquiry , Casambi on inquiry, DALI on inquiry, Phase-cut dimming on inquiry.



Generated: 21.06.2024



+48 32 388 80 00



www.cora.pl
cora@cora.pl



Street: Ignatza Hakuby 18
41-914 Bytom, Polska